

COLT

Shadometal



Architectural Solutions

# Introduction

Front Page: Zurich Airport photographed by Ralph Bensberg

Controllable perforated Colt Shadometal louvres were specified by Nicholas Grimshaw and Partners which cover the complete West facade of the A500 Airside Center. The control system adjusts the position of the louvres in response to changing climatic conditions and available daylight.

## COMFORT & SOLAR HEAT GAIN

We can all appreciate the benefits of working in an environment where the temperature is comfortable. For office buildings in the summer, the optimum temperature is 24°C, with a range of +/- 4°C.

However, this temperature range can soon be exceeded during the hotter months, due to the effect of solar radiation through glazing. Temperatures as high as 35°C to 40°C have been recorded.

This can result in an uncomfortably warm environment which can adversely affect the productivity and concentration levels of the occupants inside. In air conditioned buildings uncontrolled solar heat gain can increase cooling loads, plant size and overall running costs.

In addition, independent studies have shown that productivity increases when people sit near a window, enjoying the benefits of natural daylight. A lack of daylight can result in an over-use of artificial lighting, contributing to internal heat gain.

Architects and Consultants are increasingly recognising the part that solar shading systems can play in both enhancing the quality of the internal environment, and saving energy.

Solar shading systems can be designed to maximise natural daylight whilst controlling solar heat gain and glare.

Approved Document L2 of the Building Regulations requires avoidance of solar overheating. Please see page 4 for more details.

## SHADOMETAL

Colt offer two external solar shading systems within the Shadometal range:

**Solar C** is a fixed solar shading system as Brise Soleil that may be installed either horizontally or vertically onto the building façade or roof.

**Solarfin**, is a system of fixed or controllable fins offering greater design flexibility. When linked to a sun tracking controller, Solarfin can offer the most effective degree of solar control without compromising light levels on dull days.

Louvres are also available in other materials such as glass, wood, terracotta clay and translucent acrylics.

## COLT'S TRACK RECORD

Colt has more than 40 years experience in designing solar shading solutions.

With operating companies located worldwide, Colt has a broad product portfolio to meet your needs.

Colt was the first to incorporate electricity generating photovoltaic cells into solar shading louvres.

Colt understands that a low energy building fails on its weakest link, so it can provide integrated solutions that cover many aspects of design including daylighting and natural ventilation solutions.

Colt is dedicated to innovation and has a comprehensive design capability, including prototyping and testing facilities. We would welcome the opportunity to develop solutions to match your unique requirements.



“The challenge is to maximise daylight entry into the internal space whilst minimising solar heat gain.”

#### SUN PATH DIAGRAM

This illustration shows the azimuth and altitude of the sun for a latitude of 51.7° North

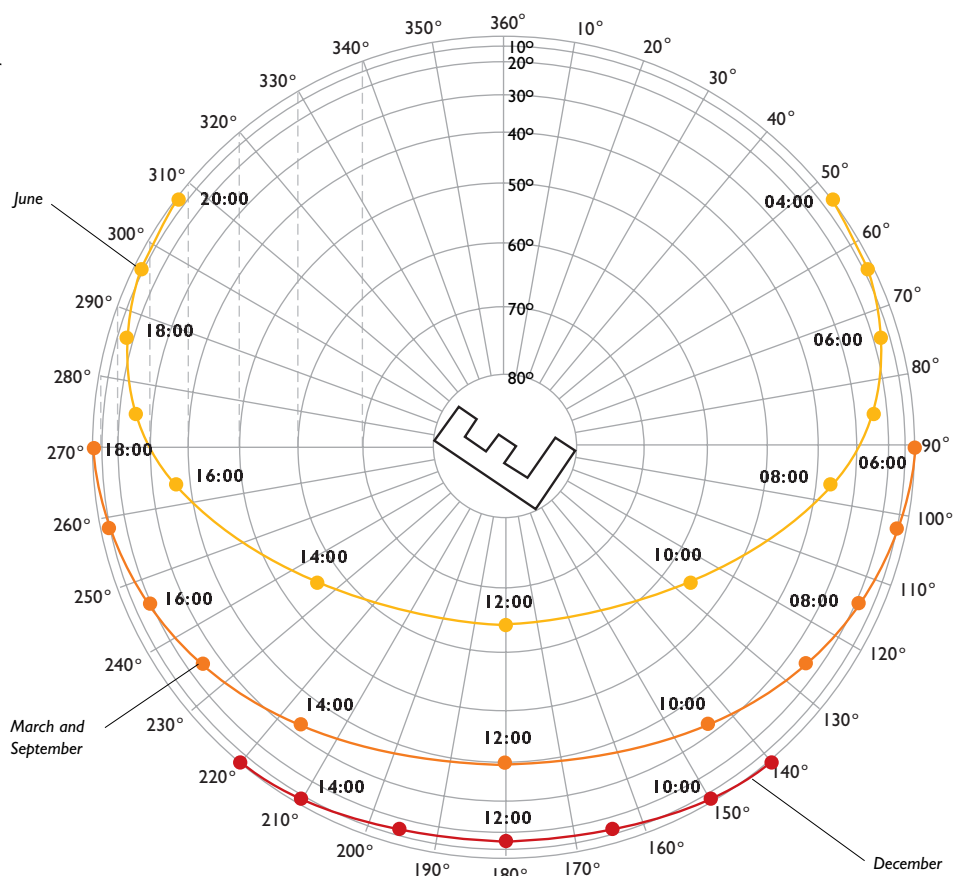

Latitude 51.7° N

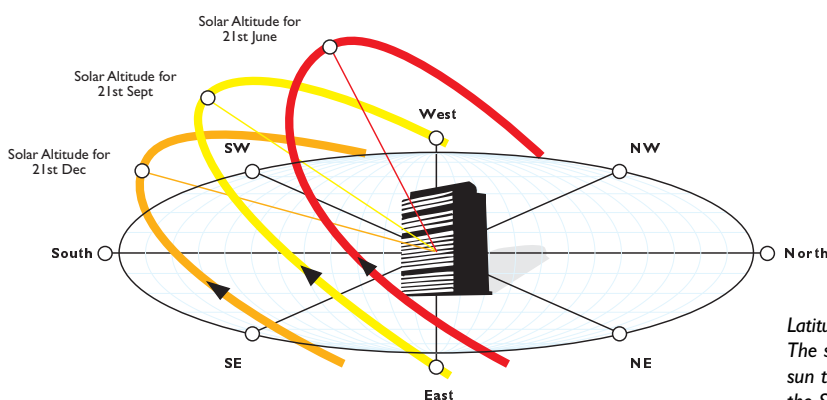

Latitude 51.7° N

The sun rises in the East and sets in the West. The sun travels in an arc, reaching its highest altitude in the South (in the Northern hemisphere)

# Building Regulations

The Building Regulations (England and Wales) require that “reasonable provision shall be made for the conservation of fuel and power in buildings”. Within this is included a requirement to limit exposure to solar overheating (2002) or excessive solar gains (2006).

This can be an onerous requirement for a highly glazed façade intended to maximise natural daylight entry.

Approved Document L2 provides guidance as to how compliance can be achieved. The guidance changes when the 2006 edition comes into force in April 2006.

A simple approach to compliance is to show that the heat gains to a defined floor area do not exceed a set average over the period between 07.30 and 17.30 in the month of July.

Until April 2006 the set average gain is a solar gain of  $25 \text{ W/m}^2$ . A calculation method is provided in Appendix H to Approved Document L2, 2002 edition.

From April 2006 the set average gain is a total gain of  $35 \text{ W/m}^2$ . The total gain includes the solar gain and casual gains due to people, lights and equipment. No specific calculation method is given, but the recommended data precludes direct use of the previous Appendix H calculation method.

Note: for spaces served by comfort cooling systems, meeting the TER (target  $\text{CO}_2$  Emission Rate) is sufficient for compliance with Regulation L1 but limiting the total gain makes it easier to meet the TER.

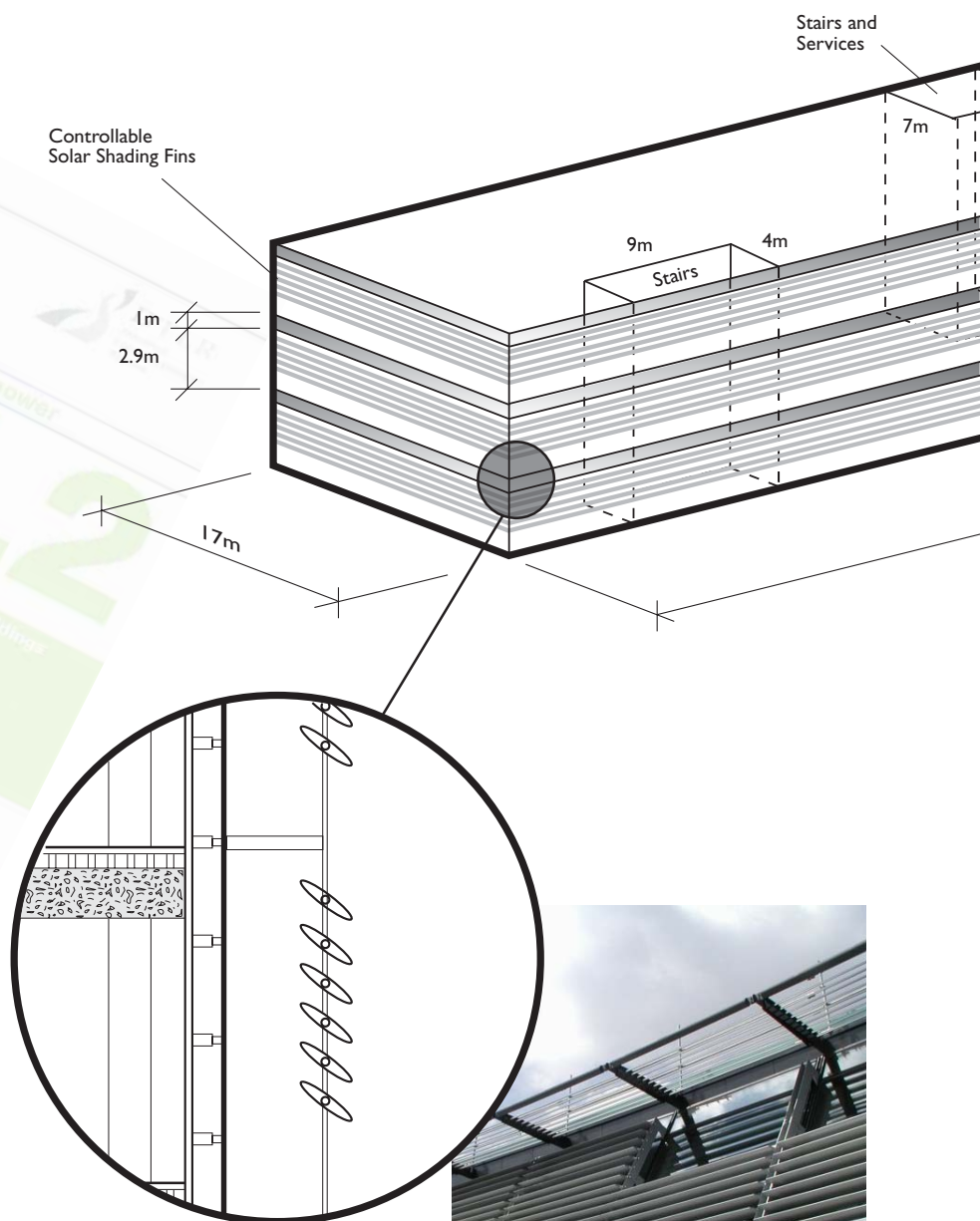

Waters Edge Visitor Centre, Barton-on-Humber.  
Fixed Solarfin louvres fitted to fitch plates to curtain walling.





Castlepoint Shopping Centre, Bournemouth.  
Solarfin louvres set onto prefabricated faceted structure.

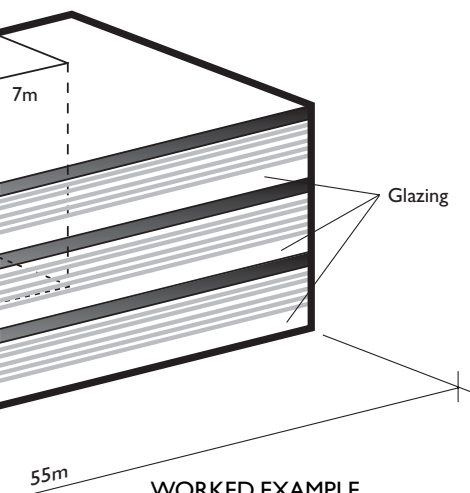

**WORKED EXAMPLE**

The following example explains the use of solar shading for compliance with clause 1.23 a) of Approved Document L2 (2002) and clause 60 a) of draft Approved Document L2A (2006). The calculation presented is from Appendix H (2002) but the general principles apply whichever document is used.

Take a typical modern fully glazed office block as shown, with heat absorbing double glazing and internal blinds to prevent glare. Assume that the floor is open plan except for the enclosed stair cores, which are disregarded. Then:

**Perimeter floor area:**

$$A_p = 642\text{m}^2$$

**Glazed area (SW+SE):**

$$A_{g1} = 182.7\text{m}^2 \quad q_{s1} = 198 \text{ W/m}^2 \text{ (*)}$$

**Glazed area (NW+NE):**

$$A_{g2} = 188.5\text{m}^2 \quad q_{s2} = 160 \text{ W/m}^2 \text{ (*)}$$

**Using the equation H1 (solar load per floor area):**

$$Q_{slw} = \frac{1}{642} (182.7 \times 198 + 188.5 \times 160) \times 0.66 \times (1 - 0.1)$$

$$Q_{slw} = 62 \text{ W/m}^2$$

(\*) Standard Data from Appendix H

This solar gain significantly exceeds the acceptable limit of 25 W/m<sup>2</sup> (2002) or (35 – casual gain) W/m<sup>2</sup> (2006).

There are two basic options available to decrease the solar gain. Reduce the glazing area or provide improved solar protection.

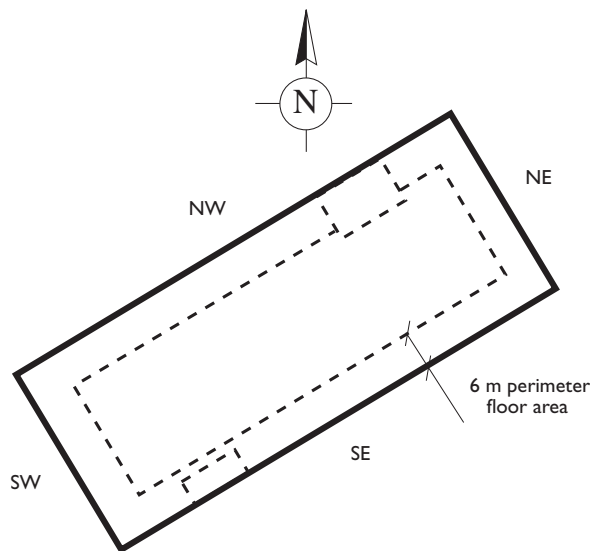

Reducing the glazing area would mean that glazing would be limited to a single strip only 1.2m high on each floor.

**Improving the solar protection to achieve 25 W/m<sup>2</sup> requires an improved correction factor of:**

$$f_c = 0.66 \times \frac{25}{62} = 0.27$$

Using equation H3 of Approved Document L2 to calculate the shading coefficient of a system to meet  $f_c = 0.27$  gives:

$$SC = 0.27 \times 0.7 = 0.19$$

**Therefore shading coefficient must be less than 0.19.**

This can be achieved using the existing glazing and blinds with the addition of an external automatically controlled movable Colt Solarfin system. Due to the effectiveness of the Solarfin system it may be possible to offset some of the additional cost by reducing the glass specification.

# Solar C - Fixed Solar Shading

An important part of the design process is to consider when it is beneficial to protect glazing from the sun. If glare is controlled by other means, such as internal blinds, it can be useful to allow winter sun into the building to supplement heating and increase light levels. Solar C Brise Soleil is ideal for this, since it can be configured to provide the required protection.

A simple horizontal Brise Soleil (such as Solar C) is best suited to façades facing between South East and South West, but with careful design Solar C can be effective on most façade orientations.

Natural light entry and 'vision out' must play an important part in the overall design process.

Consideration needs to be given to the amount of natural light entering the building, as well as the need to have a clear view to the outside.

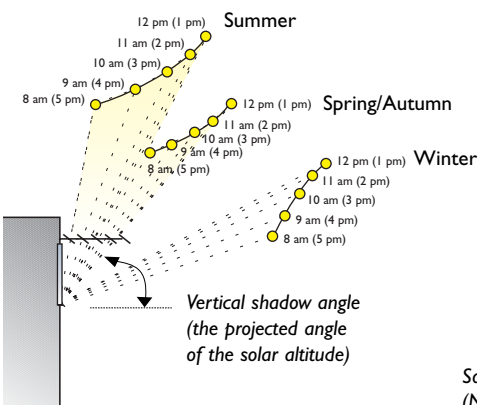

Sunfax is a program that evaluates the effectiveness of alternative solar shading designs, and which permits the selection of the most effective design.

The Solar C system is a fixed louvre system that can be designed to meet the needs of any building.

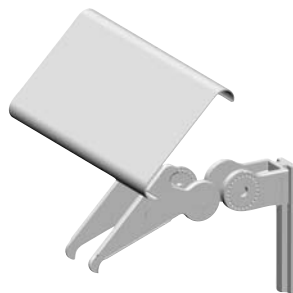

Patented louvre clip enables the louvre blades to be adjustable in increments of 15°

Unlike conventional 'Z' section shaped blades, which may reduce both direct and diffused light, the Solar C blade is designed to be effective at controlling solar heat gain whilst allowing through a fair proportion of diffused light between the louvre blades.

Six blade profiles are available varying in widths from 100mm to 150mm.

A perforated blade is also available with a width of 110mm.

The pitch between the blades is normally set at 100 mm but this can be varied to suit the blade size and angle.

Solar C is normally installed in continuous lengths to fixed rafters projecting from the building. This will provide uniform light entry to the building.

If a panellised system is preferred, then this is available with profiled end plates which can make a prominent feature to a building.

South facing  
(Northern Hemisphere)

Porsche & Volvo Offices, Munich, Germany







# Solar C - Assembly

## LOUVRE PROFILES



Type C100  
Max Span 1.65m

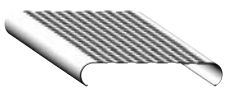

Type C100p  
Max Span 1.55m



Type C110  
Max Span 1.70m



Type C140  
Max Span 1.80m



Type C150  
Max Span 1.85m



Type C150g  
Max Span 2.00m

## FRONT FASCIA PANELS



Type FP180r  
Attached to  
Louvre Clip

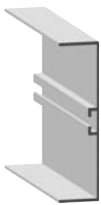

Type FP180  
Attached to  
Rafters



Type FP 90 N  
Attached to  
Rafters

## RAFTERS



Type TR 15/30  
Fixing to  
Steelwork



Type TR 23/30  
Floating  
Intermediate

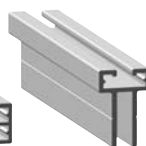

Type TR 45/30  
Cantilevered



Type TR  
50/30

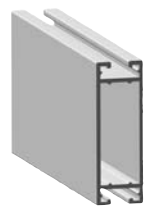

Type TR  
90/30

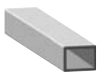

Bracing  
Strut  
20/20

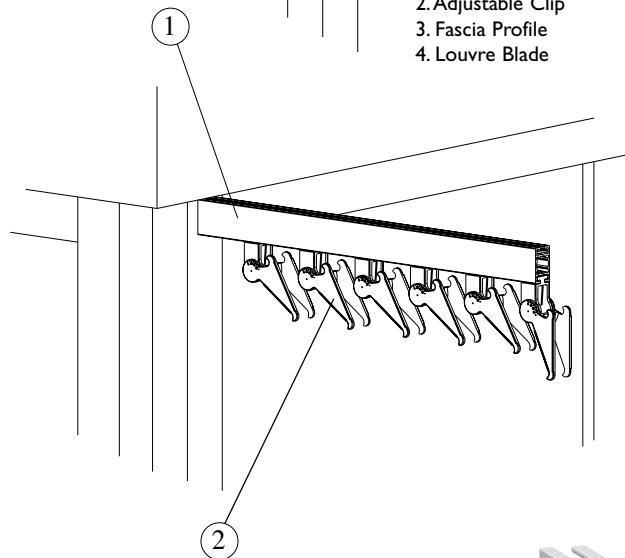
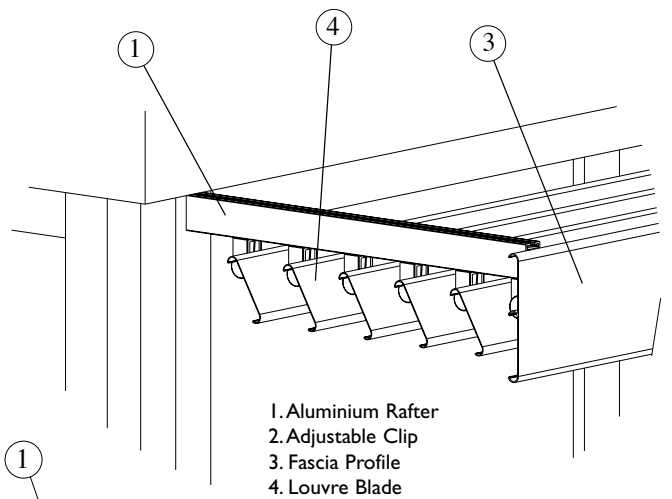





Truckstop, Dunstable.  
Bespoke vertical fins and Solar C.

### SUPPORT CLIP

Both a fixed and an adjustable clip are available. The adjustable clip allows complete flexibility of louvre and rafter angle, since the louvre angle can be changed on site.



The patented louvre clip is adjustable in increments of 15°. The action of attaching the louvre blade to the rafter fixes the angle.

Fixed angle clips are also available in 30, 45, 60 and 135°. Clips are available in either grey or translucent.

The plastic clip allows for thermal expansion of the blade and ensures that louvre blades cannot rattle against the rafters.

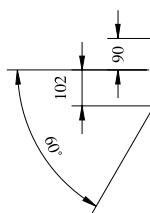

Support bracket fixed through cladding to a separate structure

### SUPPORT RAFTERS

Five basic rafter designs are available. Their selection depends on the fixing method and the loadings on the structure.

For any projections less than 1m, the rafter can be cantilevered from the building structure, assuming the windload is not excessive.

Maintenance walkways with kick plates and hand rails can be attached to the rafter to enable access for cleaning.

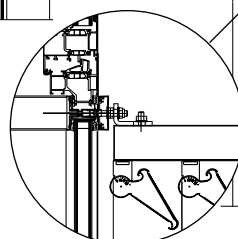
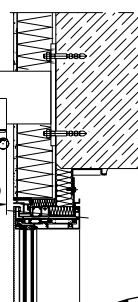
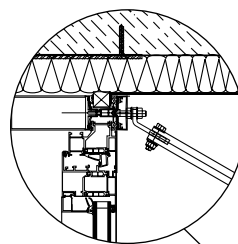

### INSTALLATION

Ideally installation should be carried out by Colt trained installers. If the louvres are installed in continuous lengths, the louvres are packaged up in break down form for on-site assembly.

An adjustment in the louvre system can accommodate building tolerances of up to 10mm.

Particular attention should be paid to suitable fixing locations and the structural integrity of the structure into which the louvre is attached. This should be considered at the early stages of the project.

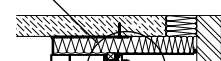

Optimum angle

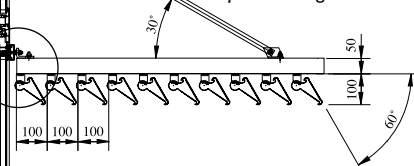

Fixed to curtain walling with bracing strut



# Solar C - Specification







*Ionica, Cambridge.*

*A solar shading system comprising aluminium support arms with circular front tubes which were infilled with Solar C blades welded to the arms and supplied as fully assembled modules.*

*Clissold Leisure Centre, London.*

*Vertical Solar C covers the glazing, which can be pivoted at an angle to facilitate easy cleaning of the glass behind.*

**Manufacturer:**

Colt International Ltd  
New Lane Havant  
Hampshire PO9 2LY  
Telephone 023 9245 1111  
Fax 023 9245 4220

**Product reference:**

Solar C type *(select from)*

C100, C100p, C110, C140, C150, C150g

*(If applicable) Facia panel type (select from)*

FP 180, FP 180r, FP 90N

**Product description:**

Fixed external solar shading system, for installation at *(select)* angle.

Louvre blades are attached to extruded aluminium box section rafters, with *(select)* variable/ fixed macrolon clips in *(select)* translucent/grey.

The system is attached to the building structure with extruded aluminium bracing struts and stainless steel brackets.

**Material:**

Louvre blades, support brackets and mullions are manufactured from extruded aluminium alloy AlMgSi<sup>0.5</sup>. Fixings are from stainless steel.

**Blade pitch and angle:**

*(select)* mm @ *(select)* degrees.

**Louvre projection:**

*(select)* Horizontal mm / Inclined / Vertical / Horizontal & Vertical / Inclined & Vertical.

**Finish:**

*(select)* Mill aluminium / Polyester powder to RAL / Anodised.



*Trinity and All Saints College, Leeds.  
Panellised horizontal Solarfin connected to end plates and fixed back to the curtain walling.*



*Marlborough House, Leatherhead.  
Solar C louvre installed onto Colt glazed pyramid with integrated Colt Firelight ventilators.*



# Solarfin - Fixed and Controllable Solar Shading







Benenden Hospital, Kent.  
The Architects John McAslan & Partners specified  
Colt Solarfin for the façade.

Colt Universal Louvre was also installed for  
screening and ventilation.

Left. The fins have virtually no impact on the view  
to the exterior.





# Solarfin - Introduction

On façades from South East to South West, a Solarfin system that is installed in front of the glazing will provide superior performance to a Brise Soleil system, whilst optimising daylight entry and the view to the exterior.

On more Easterly or Westerly façades, any fixed system will be a compromise due to the fact that the low summer sun angles need to be controlled.

A controllable Solarfin system is ideal for such façades.

Although aesthetic considerations play an important part in the design of a building, functionality is critical, both for comfort and energy saving and to meet the legal requirements imposed by Approved Document L2 of the Building Regulations.

When controllable fins, are fitted vertically in front of a window, as shown below, these may be designed to offer the most effective degree of solar control without compromising light levels on dull days.

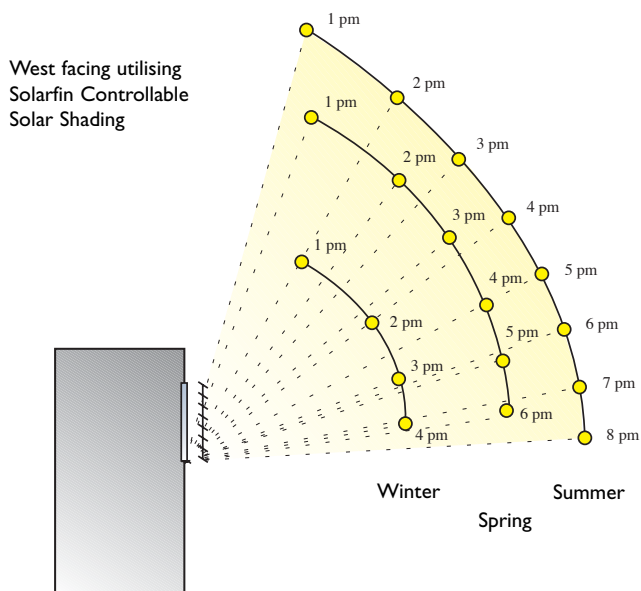





*John Lewis, Cambridge.  
Solarfin fitted both to the customer  
entrance canopy and in front of  
the facade.*



*Benenden Hospital, Kent*

Controllable fins reduce the likelihood of ‘overshading’ or ‘undershading’ that can happen with fixed solar shading. As shown below, they can be moved to the optimum shading angle depending on the time of day. On dull or overcast days the louvres will automatically open to maximise daylight entry.

On dull days, light sensors send signals to the control system to fully open the fins to allow the occupants maximum natural daylight and vision to the outside at all times.

Controllable solar shading is also effective when fitted to glazed rooflights.



*Clear Channel Outdoor, London.  
Both fixed and movable vertical  
Solarfin louvres installed onto  
the facade.*



*Bristol Myers Squibb, Liverpool.*

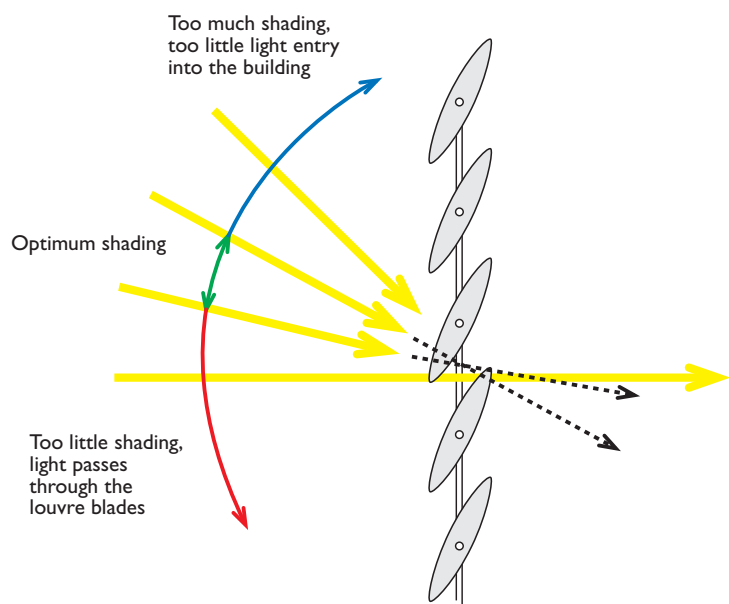



# Solarfin



*Health and Safety Executive, Bootle.  
Colt both the supplied the horizontal Solarfin and the  
supporting steelwork. Colt also provided natural and  
smoke ventilation, fire curtains, rooflights and weather  
and screening on this project.*





*Tate Britain, London.  
Controllable Solarfin fins installed on top of  
Colt Azur rooflight systems.*

## COLT SOLARFIN

Colt Solarfin is a fixed or controllable external solar shading system that may be installed either vertically or horizontally in front of the façade.

It may be combined with other Colt products such as rooflights and glazed façades.

A Solarfin shading system can reduce solar heat gain, lower air conditioning running costs, and lessen glare whilst maximising the use of natural daylight.

With over 20 standard profiles, fins are available as one-piece extrusions in widths up to 400mm and as multiple clipped together extrusions in widths up to 1050mm.

Solarfin louvres may be fixed at any angle and can rotate under motorised control. Spans can be up to 6m without intermediate support and up to 10m with intermediate bracing rods. Fabricated and perforated fins are also available.

All principal components are manufactured from extruded aluminium alloy type 6063 T6 with stainless steel fixings. Controllable fins can pivot through 120 degrees and can be controlled by astronomical data operating the actuators to track the path of the sun.

## SUNFAX

Sunfax is a specially designed computer program that evaluates the effectiveness of a solar shading system. With this program Colt can assess a system design and provide a bespoke solution to meet all aspects of a project.

Backed by an experienced technical support team, Colt can work with the customer from the earliest stages of the project to design an aesthetically pleasing, high performance solar shading system.



*Arup Fitzrovia, London.  
Fixed Solarfin supported  
by drop rods, and  
Universal Louvre fitted  
to plant rooms.*



# Solarfin Standard Profiles

## STANDARD RANGE

CEL 60/20



CEL 120/20

CEL 150/34



CEL 200/34

CEL 250/40

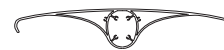
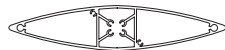

CHL 250/40

CEL 300/50

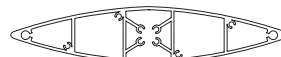

CEL 350/55

CEL 400/60

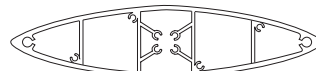
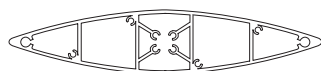

CEL 400/80

CEL 480/80

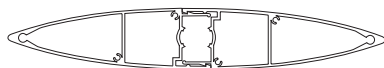

**NOT TO SCALE**

Perforated

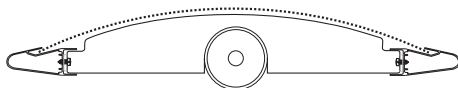

Perforated 250/50

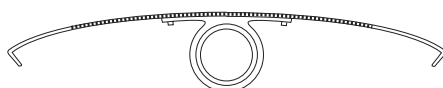

Special profiles available on request

# Solarfin Specification

## Manufacturer:

Colt International Ltd  
New Lane Havant  
Hampshire PO9 2LY  
Telephone 023 9245 1111  
Fax 023 9245 4220

## Product reference:

Colt Solarfin type  
(select from standard range)

CEL 150/34, CEL 200/34,  
CEL 250/40, CEL 300/50,  
CEL 350/55, CEL 400/60 and  
CHL 250/40,

or telephone Colt to discuss your special requirements.

## Product description:

(select) Controllable / Fixed external solar shading system, designed to reduce solar glare and solar heat gain.

Extruded aluminium fin profiles are designed to prevent or reduce direct radiation through windows in summer, while keeping visibility through windows as clear as possible.

## Material:

Fins and rafters are manufactured from extruded aluminium alloy 6063 T6. Fixings are from stainless steel.

## Fin pitch and angle:

(select) mm @ (select) degrees.  
(Select angle for a fixed system only).

## Finish:

(select) Mill aluminium / Polyester powder to RAL / Anodised.

Stainless steel components to be self-finished if applicable.

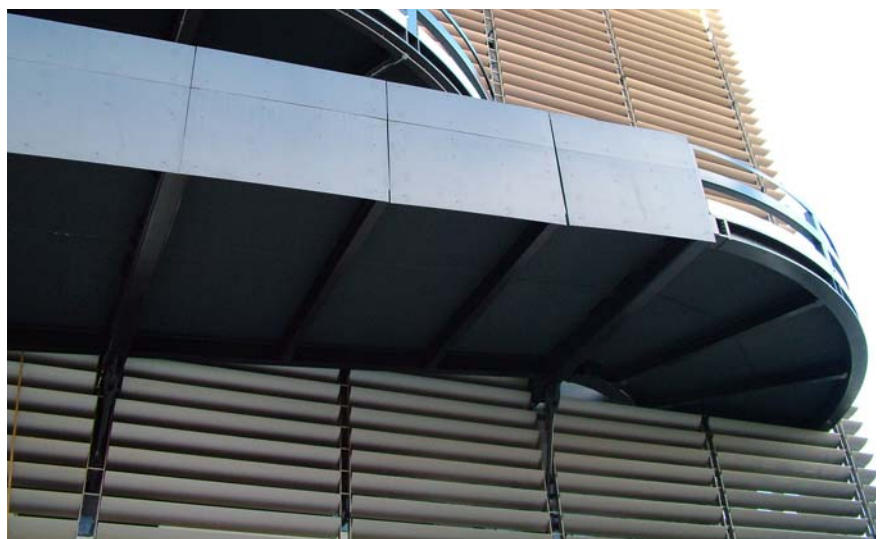

Paradise St Car Park, Liverpool  
Fixed Solarfin with special ladder mullion system  
and mitred corners.



# Bespoke Profiles

Colt realise the importance of creativity and individuality when designing a building and offer many bespoke solar systems in such materials as perforated aluminium, wood, terracotta clay, and translucent acrylics.



*Asda, Poole.  
Fixed Solarfin fitted to vertical steel supports.*



*UTZ Offices, Berlin, Germany.  
Bespoke vertical solar shading fins that can be manually altered to control internal daylight levels.*



*Addenbrookes Hospital, Cambridge.  
Perforated cladding and perforated Solarfin for screening and ventilation.*



*Aldersgate, London.  
Curved horizontal screening fins and panelised louvre panels.*



*Crosby Leisure Centre, Liverpool.  
Stucco embossed aluminium louvres set onto  
prefabricated faceted structure.*



*Natural History Museum, London.  
Between the Colt glass façade and walkway of the stunning South façade is a bespoke, controllable fin,  
which is half perforated to provide additional daylight when in the closed position*



*SD Worx, Germany.  
Controllable perforated Shadometal.*



# Control Systems

## TOTAL CONTROL

Although fixed solar shading performs well on a South facing façade, performance is dramatically reduced on a East or West facing façade which receives a large amount of sunshine during the day.

A controllable shading system can best overcome this problem. Sun tracking louvres follow the path of the sun, making sure the solar shading system always optimises the amount of daylight entry.

On dull or overcast days the louvres are controlled in such a way that if clouds pass over the building, the louvres will automatically open to maximise daylight entry and then later revert back to their original position.

The Sun path diagram (right) for latitude 52°N shows the position of the sun throughout the day during the months of June, March/September and December.

## CONVENTIONAL ACTUATION



## PIA (HIDDEN ACTUATOR) SYSTEM

The innovative PIA system is a mullion integrated drive system which is available for all movable systems.

Large exposed actuators are no longer required since the PIA system provides central pivoted control within the mullions.

## PIA SYSTEM

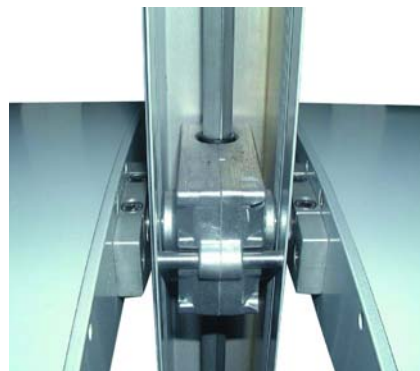

Usually drive mechanisms for solar shading systems are visible. The PIA control system allows the control mechanisms to be housed out of sight within the mullions. In addition to this aesthetic feature, each control mechanism within the mullion can drive the louvres from 0° to 360°. This enables greater flexibility of application for light reflection or cleaning for example.

Unobtrusive, compact façades can be created which are equally suited for both vertical and horizontal applications, with almost silent running operation when the louvres are moving. Installation is very simple since all components are supplied fully pre-assembled. Also, the mechanical integrity of the system is assured: since the louvres are individually fixed into their bearings, the likelihood of structural failure is very much reduced.

*The control mechanism is discreetly contained within the mullion instead of hanging externally.*



*Ilford recorder, Ilford.  
A series of movable Solarfin louvres were integrated into a "PIA" mullion-integrated actuation system consisting of box section mullions with hidden mechanisms inside, controlled by a Colt ICS 4-Link control system.*

Colt Solar Shading systems may be controlled in three different ways:

- Hand control via lever or crank handle.
- Electrically operated via actuators, which require a controller such as ICS 4-Link, SolTronic or a client BMS.
- Self powered via a thermal hydraulic controller Colt Girasol. This operates autonomously and requires no additional source of power other than the sun.

#### GIRASOL

Girasol operates solar shading louvres without the need for electrical power or a sophisticated control system.

Absorber tubes, enclosed by mirrors, force a hydraulic cylinder to open or close the louvres according to the position of the sun.

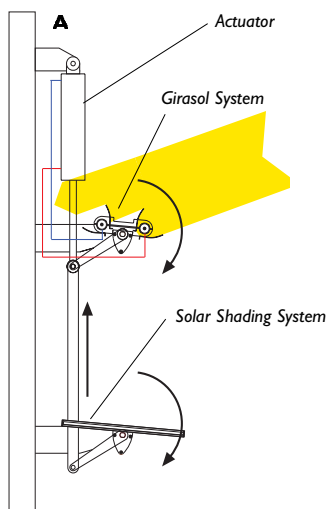

*Tubes are filled with a special hydraulic fluid and as the sun moves over the building, there will be an imbalance of heat between the two tubes and the louvres will open or close as appropriate.*

#### ICS 4-LINK

ICS 4-Link is ideally suited to larger projects with more complex control requirements.

It is a generic control system that can operate HVAC, smoke control and solar shading systems.

It has a wide variety of operating modes, including sun tracking, daylighting optimisation and PV illumination. It responds to timers and sensors to ensure that the building 'reacts' appropriately to the sun's position and to the weather.

Remote operation is available via an internal modem interface and a manual override is also possible.



*This control system may run on any conventional PC.*

#### SOLTRONIC

SolTronic is ideally suited for small to medium sized projects.

It is a simplified version of ICS 4-Link and can control up to ten actuators in any single zone.

It responds to external weather conditions automatically calculating the position of the sun, and adjusts the position of the louvres accordingly.





## COMMISSIONING

Proper commissioning of movable Solar Shading Systems by experts is essential. We recommend that our specialist staff commission and certify the system.

## COLT SERVICE

Part of the Colt Group of companies, Colt Service offers a comprehensive range of maintenance packages incorporating the maintenance and repair of all building services equipment including non Colt products.

Colt Service provide a 24 hour, 365 day emergency cover as standard.

## MAINTENANCE & TESTING

Colt solar shading systems require virtually no maintenance.

All components of any system should be serviced at least once a year and tested monthly.



“People feel better in Colt conditions”



Architectural Solutions  
Climate Control  
Smoke Control  
Service and Maintenance

**Colt International Limited**  
New Lane Havant  
Hampshire PO9 2LY  
Tel +44(0)23 9245 1111  
Fax +44(0)23 9245 4220  
info@coltgroup.com  
www.coltgroup.com